

Article number: 2307030711

Description: E+G Solid handwheel
VDC.160-GXX2+I

Measures

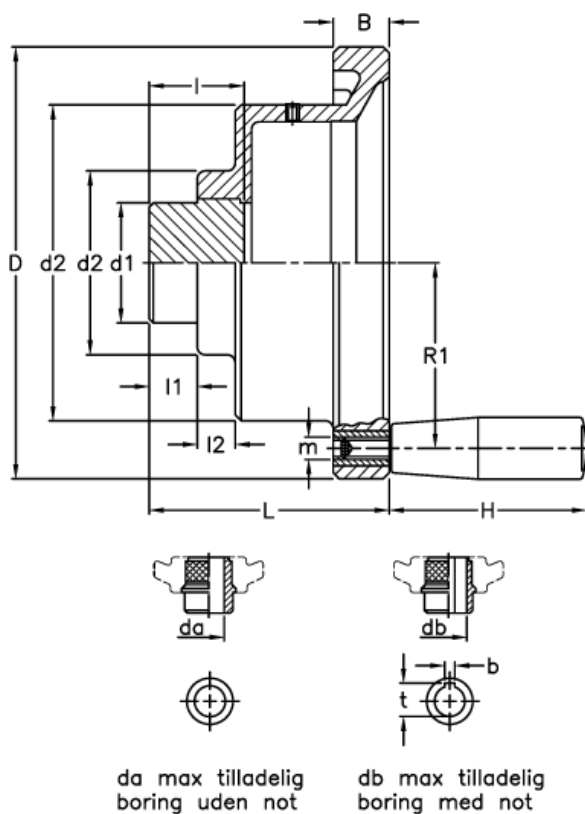

b = 8	H = 80
B = 18	l = 30
D = 160	L = 72
d1 = 35	l1 = 15
d2 = 53	l2 = 10.0
d3 = 84	m = M8
da = 30	R1 = 68.0
db = 24	t = 27.3